

ULTRA



Equipment Designed for Roller Shade Makers

CUTTING



ULTRA SB • ULTRA SC • ULTRA SE

WELDING



ULTRA WX • ULTRA MG • ULTRA WH2.0

ASSEMBLY



ULTRA PT • ULTRA PTX • ULTRA RG

2023-24 EQUIPMENT CATALOG

ULTRA • TAB



Ultratab brings 15 years of experience and innovation to the window covering and shading industry. We are the leading supplier worldwide of ultrasonic cutting machines, impulse welders, and several other fundamental tools for high performance fabrication systems. While emphasizing safety, we present complete solutions for efficient production and also provide domestic and global tech support.

Over the years we have expanded our lines of equipment to integrate state of the art technology and design for greater control and optimal performance. All Ultratab equipment include key safety features and automation options. Commitment to our customers' success keeps Ultratab developing new machines for the ultimate solution to fabrication. With a history of over 30 years' experience, working side-by-side with manufacturers in the industry, we develop our equipment with a strong understanding of the essential needs for fabricators. Our entire Ultratab team is here to provide the best solution for your business and is committed to excellent after-sale service.

INTERNATIONAL SALES & SUPPORT CONTACTS

USA, Canada, and Latin America:



SEN**BESTA**

PHONE: +1 (626) 256-4800
EMAIL: sales@senbesta.com
ADDRESS: 1901 S Mountain Ave
Monrovia, CA 91016 USA
WEBSITE: www.senbesta.com
DEMO VIDEOS: www.youtube.com/ultratab

Asia, Europe, Africa, and Australia:



PHONE: +852 233 12121
EMAIL: pacino@ultratab-asia.com
ADDRESS: Flat D, 5/F, Yeung Yiu Chung,
(No.8) Ind. Bldg, No. 20 Wang Hoi Road
Kowloon Bay, Hong Kong, China

CONTENTS

02	Introduction
03	Contact Information
04	Table of Contents
05	Ultra SB
06	Ultra SE
07	Ultra SC
08	Ultra SR
09	Ultra SX
10	Ultra VW 2.0
11	Ultra XY 1.0
12	Ultra XY 2.0
13	Ultra SM 1.0
14	Ultra SM 2.0
15	Ultra XTC 2.0
16	Ultra RBS
17	Ultra WS
18	Ultra WX
19	Ultra MG
20	Ultra WH 1.0
21	Ultra WH 2.0
22	Ultra PT
23	Ultra PTX
24	Ultra TM2
25	Ultra RG
26	Ultra FRC
27	Service & Support



05
CUTTING

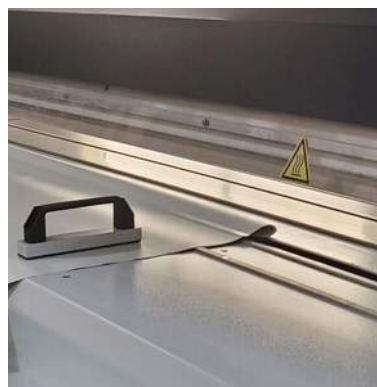

17
WELDING



22
INSPECTION



24
ASSEMBLY



ULTRA SB

The **ULTRA SB Dual Cutting Table** features two blade options, **Ultrasonic** and **Crush cut**. By having both cutting mechanisms it allows manufacturers to quickly and precisely cut any type of roller shade fabric, such as delicate, sheer, zebra, blackout, and screen fabrics. This machine presents endless possibilities as to what types of fabrics you can fabricate; it is the ideal cutting table for window shade manufacturers.

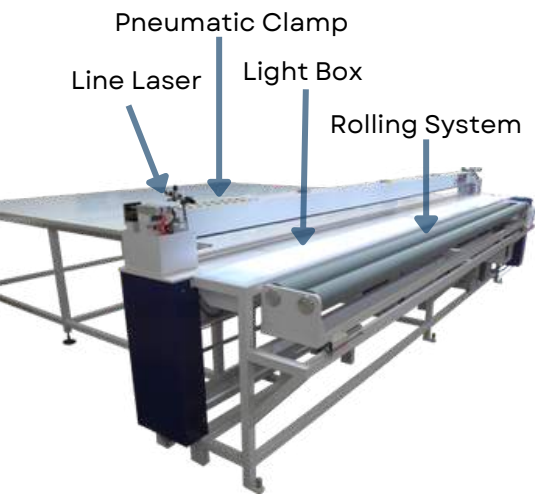

CUTTING WIDTHS:

- 3.2M (10' 6")
- 4.0M (13' 1")
- 4.5M (14' 9")



TECHNICAL SPECIFICATIONS:

- Voltage:** 110V or 220V, Single Phase
- Wattage:** 1500 Watts
- Air Requirements:** 6-8 bar (kg/cm2)



OPTIONAL UPGRADES:

- Plexiglass Table Tops** (5ft/table)
- MDF Table Tops** (4ft/table)
- Automatic Length Guide**
- Line Laser**



[▶ Watch the Demo](#)

Features

- ✓ Automated Crush and Ultrasonic Blades with Adjustable Speed Control
- ✓ Motorized Rolling System – Conveniently operated through Control Panel and Kick Bars
- ✓ Plexiglass Table Tops Available in 5ft Sections
- ✓ Fabric Light Inspection Box
- ✓ Pneumatic Clamp
- ✓ Manual Length Guide

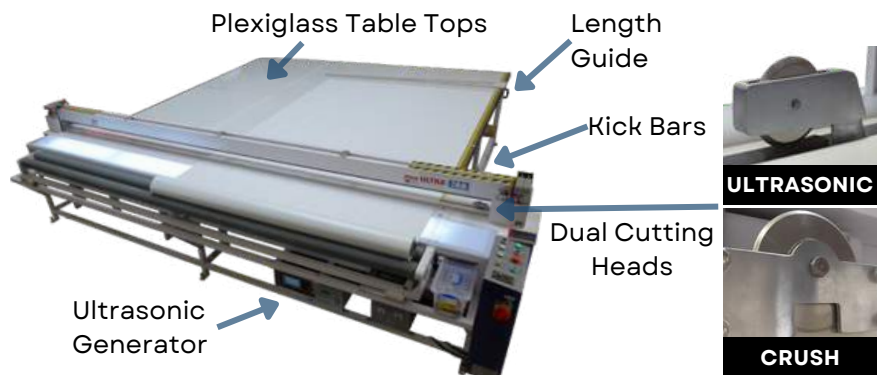



ULTRA SE

The **ULTRA SE Ultrasonic Cutting Table** will drastically reduce production time by efficiently and effectively cutting roller shade fabrics. The Ultrasonic cutting method thoroughly seals the edge of the fabric, and as a result it is the best solution for fabrics that tend to fray easily.

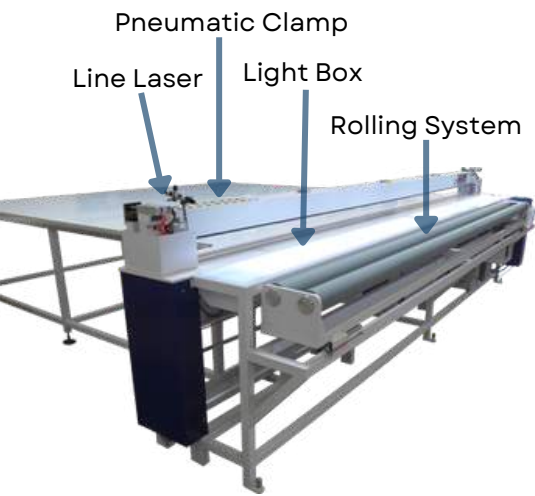

CUTTING WIDTHS:

- 3.2M (10' 6")
- 4.0M (13' 1")
- 4.5M (14' 9")



TECHNICAL SPECIFICATIONS:

- Voltage:** 110V or 220V, Single Phase
- Wattage:** 1500 Watts
- Air Requirements:** 6-8 bar (kg/cm²)



OPTIONAL UPGRADES:

- Plexiglass Table Tops (5ft/table)
- MDF Table Tops (4ft/table)
- Automatic Length Guide
- Line Laser

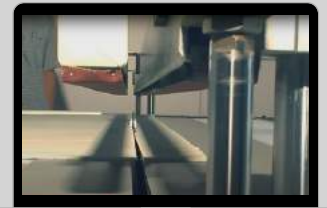

[▶ Watch the Demo](#)

Features

- ✓ Automated Ultrasonic Blade with Adjustable Speed Control
- ✓ Ultrasonic Edge Sealing Technology
- ✓ Motorized Rolling System - Conveniently operated through Control Panel and Kick Bars
- ✓ Plexiglass Table Tops Available in 5ft Sections
- ✓ Fabric Light Inspection Box
- ✓ Pneumatic Clamp
- ✓ Manual Length Guide

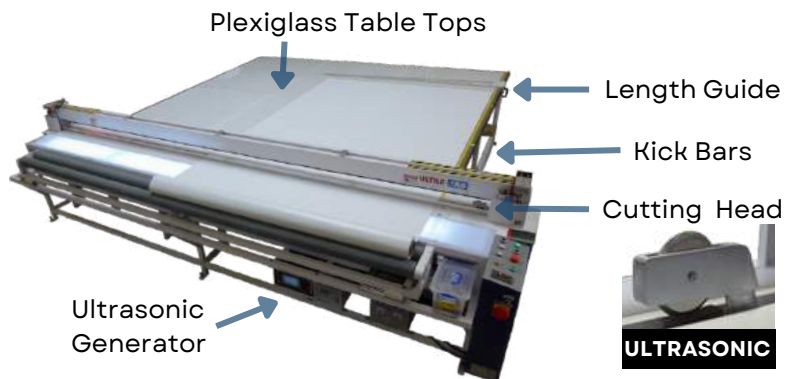



ULTRA SC

The **ULTRA SC Crush Cutting Table** offers a clean and precise cutting edge. The Crush cut is recommended for interior fabrics such as blackout, light filtering, sheer and laminated materials, and also most exterior fabrics, subject to testing. The table includes a rolling rack, fabric light inspection box, manual length guide, and a pneumatic clamp.

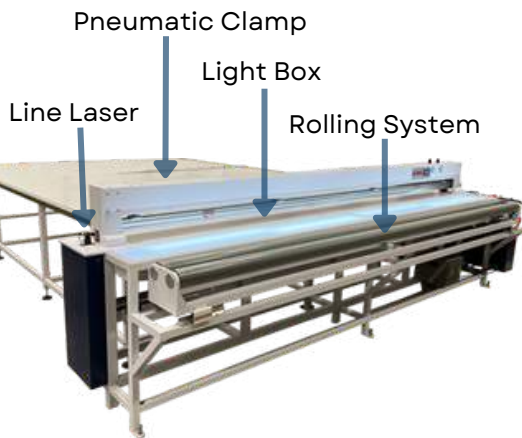

CUTTING WIDTHS:

3.2M (10' 6")
4.0M (13' 1")
4.5M (14' 9")



TECHNICAL SPECIFICATIONS:

Voltage: 110V or 220V, Single Phase
Wattage: 1500 Watts
Air Requirements: 6-8 bar (kg/cm²)



OPTIONAL UPGRADES:

Plexiglass Table Tops (5ft/table)
MDF Table Tops (4ft/table)
Automatic Length Guide



[▶ Watch the Demo](#)

Features

- ✓ Automated Crush Blade with Adjustable Speed Control
- ✓ Motorized Rolling System – Conveniently operated through Control Panel and Kick Bars
- ✓ Plexiglass Table Tops Available in 5ft Sections
- ✓ Fabric Light Inspection Box
- ✓ Pneumatic Clamp
- ✓ Manual Length Guide

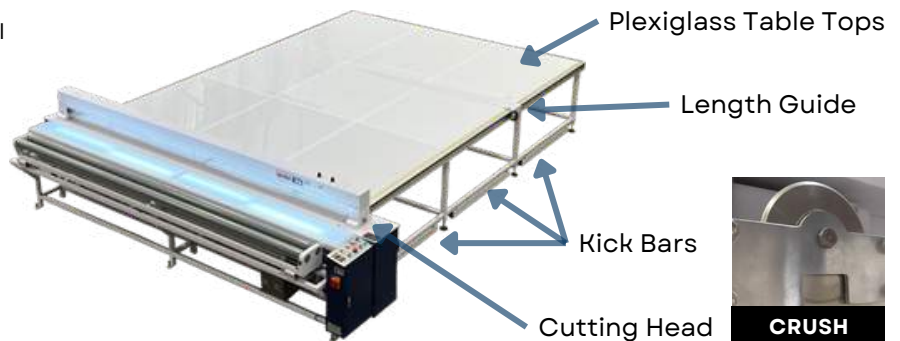



ULTRA SR

The **ULTRA SR Cold Cutting Table** is a simple, easy to operate cutting machine that provides **precise cuts for making window shades**. The solid steel-based table is the optimal partner for manufacturers. It can cut all types of roller shade fabrics and produce a clean, flawless square cut.



CUTTING WIDTHS:

3.2M (10' 6")
4.0M (13' 1")
4.5M (14' 9")



TECHNICAL SPECIFICATIONS:

Air Requirements: 6-8 bar (kg/cm²)



OPTIONAL UPGRADES:

MDF Table Tops (4ft/table)

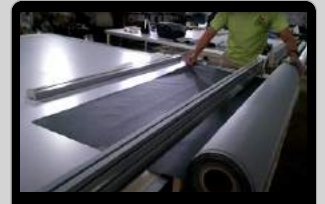

[▶ Watch the Demo](#)

Features

- ✓ Manual Cold Cutter
- ✓ Straight and Square Cut
- ✓ MDF Table Tops Available in 4ft Sections
- ✓ Pneumatic Clamp
- ✓ Manual Length Guide
- ✓ Simple and easy to operate

Pneumatic Clamp →

Manual Cold Cutter
(Razor Blade) →

Fabric Cradle →

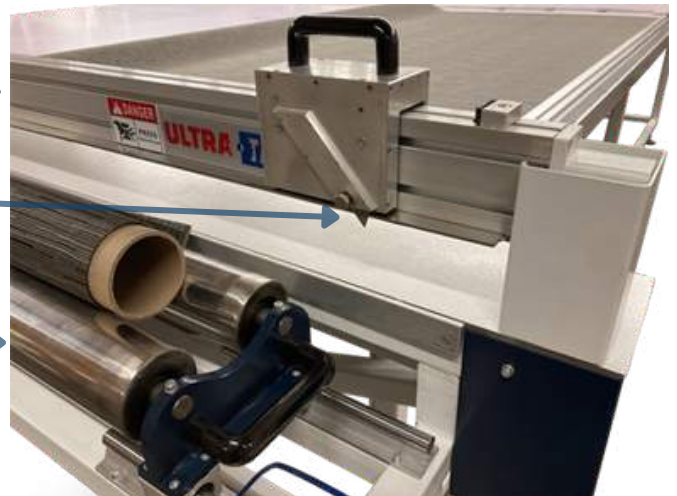



ULTRA SX

The **ULTRA SX, Ultrasonic, Crush and Rotary Cutting Table**, is essentially our **ULTRA SB** with a **high-speed rotary cutter added at the end**. This machine allows manufacturers to utilize their workspace and maximize their production by using both the ends at the same time. The rotary cutter works well for exterior fabrics, and cutting multiple layers at once, while the crush and ultrasonic work well for interior fabrics and sealing the edge of fabrics that tend to fray.

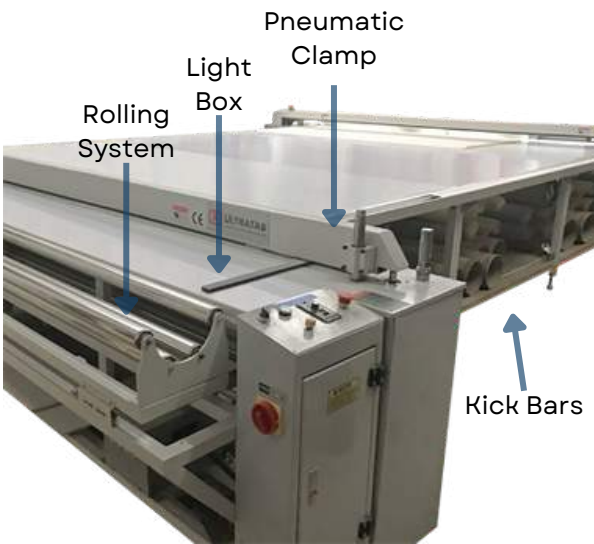

CUTTING WIDTHS:

3.2M (10' 6")
4.0M (13' 1")
4.5M (14' 9")



TECHNICAL SPECS:

Voltage: 110V or 220V, Single Phase
Wattage: 1500 Watts
Air Requirements: 6-8 bar (kg/cm²)



OPTIONAL UPGRADES:

Plexiglass Table Tops (5ft/table)
MDF Table Tops (4ft/table)
Line Laser



[Watch the Demo](#)

Features

- ✓ Automated Crush, Ultrasonic & High-Speed Rotary Blades with Adjustable Speed Control
- ✓ Motorized Rolling System – Conveniently operated through Control Panel and Kick Bars
- ✓ Plexiglass Table Tops Available in 5ft Sections
- ✓ Fabric Light Inspection Box
- ✓ Pneumatic Clamp
- ✓ Manual Length Guide

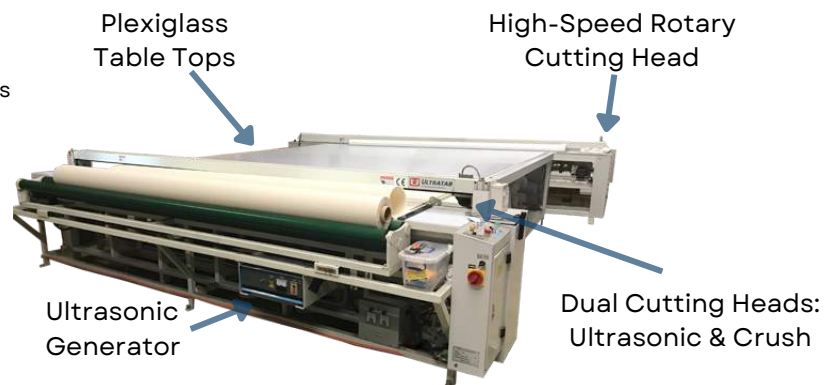



ULTRA VW 2.0

The **ULTRA VW 2.0 Fabric Inspection Machine** neatly displays the material in a well-lit, upright position for easy assessment. It is fully automated, includes a two-way LED light box system, dual motors, auto alignment system, electric scale counter, wireless remote and manual cutting system with a pneumatic clamp for single user operation.

Dual Motorized Roller System

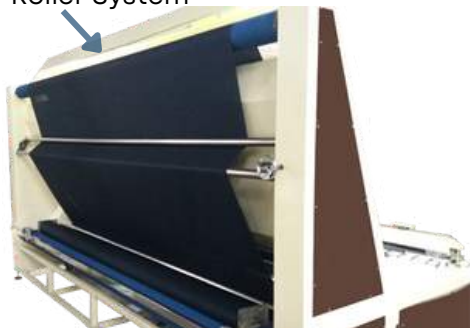

TECHNICAL SPECIFICATIONS:

Working Width: 3.2M (10' 6")
Wattage: 1500 Watts
Voltage: 110V or 220V, Single Phase
Air Requirements: 6-8 bar (kg/cm2) or 90-110 psi



EQUIPMENT DIMENSIONS:

Machine: 156" x 91" x 102" (WxLxH)
LED Light Box: 118" x 39" (LxH)



[▶ Watch the Demo](#)

Features

- ✓ Two-way LED Lighting System
- ✓ Dual Motorized Roller System - Front and Back
- ✓ Manual Cold Cutter with Pneumatic Clamp
- ✓ Auto-Alignment System
- ✓ Adjustable Rolling Speed
- ✓ Electric Scale Counter for Measurement
- ✓ Wireless Remote - Control Rolling Forward or Backward



Control Panel

Manual Cold Cutter

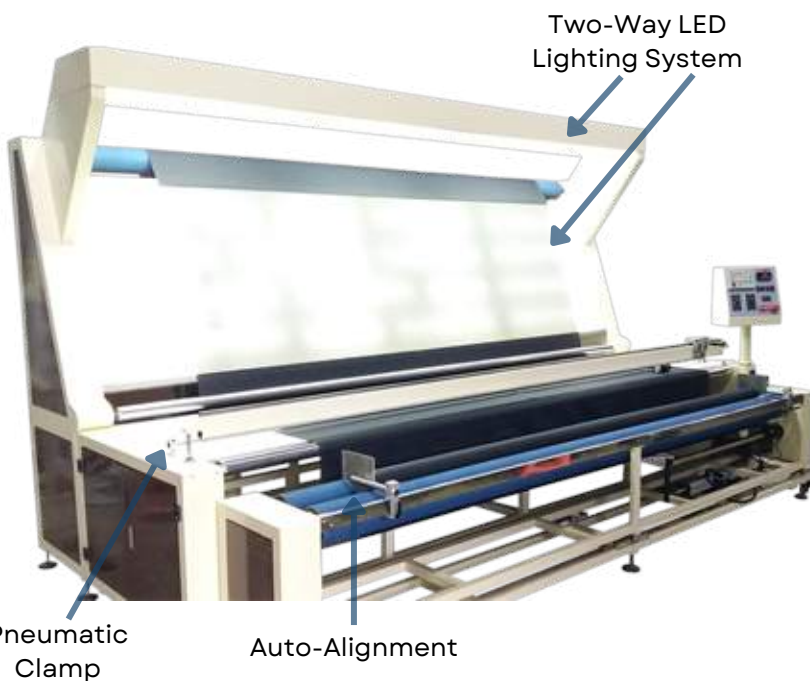

Two-Way LED Lighting System

Pneumatic Clamp

Auto-Alignment

ULTRA XY 1.0



The **ULTRA XY 1.0 Multi-Blade Cutting Machine** is a powerful machine that feeds out cut-to-size shades using an X-Knife cutter and three Y-Crush cutters to cut both the width and length of the shades. It is best used for high production commercial jobs when cutting the same size shades on repeat. This space saving unit does not require any tabletops. It is easily operated by one person and cuts automatically hundreds of shades with limited supervision and time.

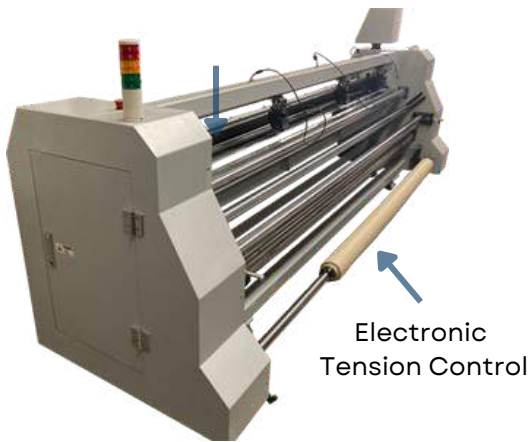

CUTTING WIDTH:

3.1M (10' 2")



TECHNICAL SPECIFICATIONS:

Wattage: 1500 Watts

Air Requirements: 6 kg/cm²

Voltage: 110V or 220V, Single Phase

Control: Touch Screen, Programmable PLC



OPTIONAL UPGRADES:

Additional Crush Blade

Additional Cone Lockset

Automatic Re-Winding

Lining and Marking Devices



[▶ Watch the Demo](#)

Features

- ✓ Longitude and Latitude (XY) cutting is performed simultaneously by Knife and Crush cutters
- ✓ Includes 3 Crush Blade Cutting Units
- ✓ EPC (Edge Position Control) allows cutting out irregularly defective fabric
- ✓ Touch Screen, Programmable PLC Control
- ✓ USB Memory Data Transportation
- ✓ Automatic Fabric Roll Pulling & Tension Control
- ✓ Electric Foot Switch
- ✓ Casters
- ✓ No Working Table Required

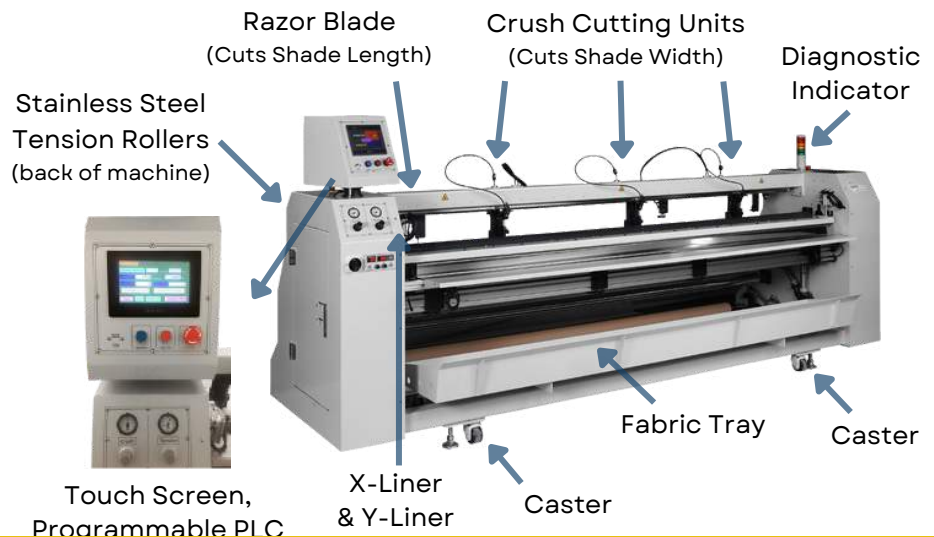



ULTRA XY 2.0

The **ULTRA XY 2.0 Multi-Blade Cutting Machine** is a powerful machine that feeds out cut-to-size shades using an X-Knife cutter and three Y-Ultrasonic or Crush cutters to cut both the width and length of the shades. It is best used for high production commercial jobs when cutting the same sized shades on repeat. The 2.0 model has the added feature of interchangeable blades for cutting the width of the shades. Users are able to choose the best cutting mechanism for their fabric, either Ultrasonic or Crush cut. This space saving unit does not require any tabletops. It is easily operated by one person and cuts automatically hundreds of shades with limited supervision and time.



Ultrasonic Blade Crush Blade



CUTTING WIDTH:

3M (9' 10")



TECHNICAL SPECIFICATIONS:

Wattage: 1500 Watts

Air Requirements: 6 kg/cm2

Voltage: 110V or 220V, Single Phase

Control: Touch Screen, Programmable PLC



OPTIONAL UPGRADES:

Additional Y-Axis Blade (Ultrasonic & Crush)

Additional Cone Lock Set

Automatic Re-winding

Lining and Marking Devices



[▶ Watch the Demo](#)

Features

- ✓ Longitude and Latitude (XY) cutting is performed simultaneously by Ultrasonic or Crush (Y Axis) and Knife (X Axis)
- ✓ Includes 3 Ultrasonic & Crush Blade Cutting Units
- ✓ EPC (Edge Position Control) allows cutting out irregularly defective fabric
- ✓ Touch Screen, Programmable PLC Control
- ✓ USB Memory Data Transportation
- ✓ Automatic Fabric Roll Pulling & Tension Control
- ✓ No Working Table Required

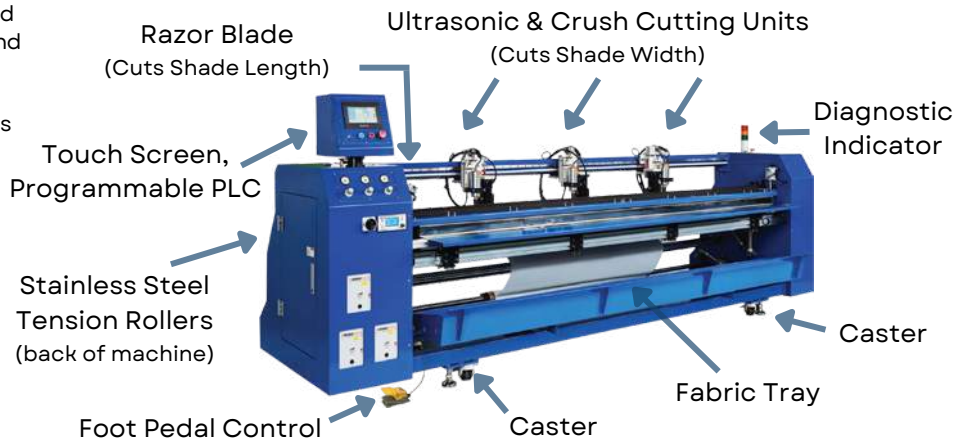



ULTRA SM 1.0

The **ULTRA SM Multi-Blade Cutting Machine** is designed to cut sheer elegance or zebra shade fabrics. The ULTRA SM uses four razor blades which allow users to cut up to three shades at once. This machine does not require a table and comes equipped with castors, which makes it easy to adjust the positioning and placement in your workshop.

Manual Measuring Guide



CUTTING WIDTH:
3M (9' 10")



TECHNICAL SPECIFICATIONS:
Power: 300 Watts
Air Requirements: 6 kg/cm2
Voltage: 110V or 220V, Single Phase



OPTIONAL UPGRADES:
Additional Cutting Unit
Additional Stainless Steel Tube



[▶ Watch the Demo](#)

Features

- ✓ Longitude (Y axis) and Latitude (X axis) cutting is performed simultaneously by Knife Blade
- ✓ Cut Multiple Shades at Once
- ✓ Four Separate Cutting Heads on Unit
- ✓ Automatic Fabric Roll Pulling & Tension Control
- ✓ Electric Foot Switch
- ✓ No Working Table Required

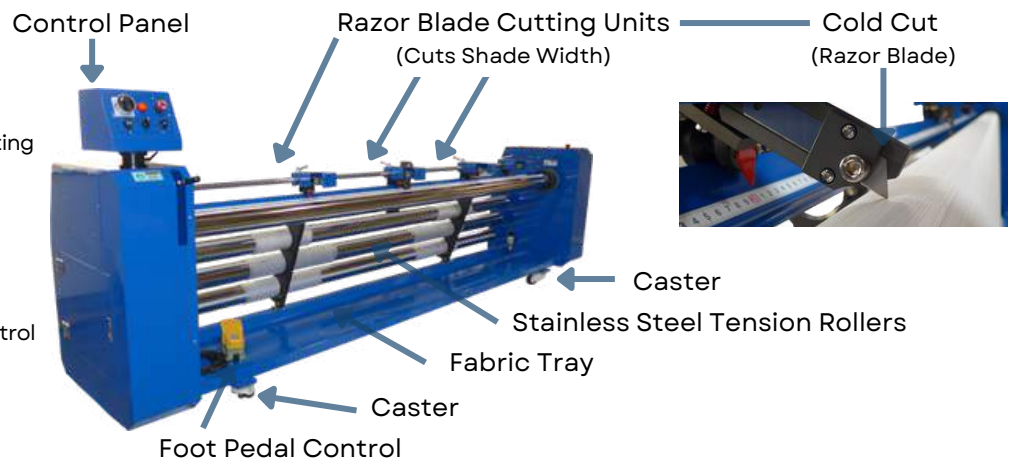



ULTRA SM 2.0

Touch Screen,
PLC Control



Easy to change
and set blades



Automatic
Rewinding and
Extraction

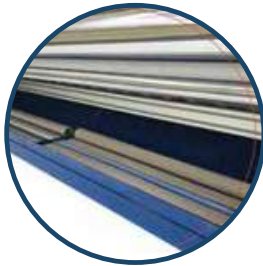

The **ULTRA SM 2.0 Multi-Blade Cutting Machine** is a cutting-edge solution for manufacturing sheer elegance or zebra shades in high volumes. This state-of-the-art machine is equipped with four cutting heads to simultaneously cut multiple shades at once, ensuring large quantities of fabric can be cut with precision and speed. Using this tool helps to minimize waste and maximize production efficiency.



CUTTING WIDTH:
3M (9' 10")



OPTIONAL UPGRADES:
Additional Cutting Unit
Additional Stainless Steel Tube
MES Data Transportation
Additional Conveyor



TECHNICAL SPECS:

Wattage: 300 Watts
Air Requirements: 6 kg/cm²
Voltage: 110V or 220V, Single Phase

Features

- ✓ Longitude (Y axis) and Latitude (X axis) cutting is performed simultaneously by Knife Blade
- ✓ Cut Multiple Shades at Once
- ✓ Four Separate Cutting Heads on Unit
- ✓ Automatic Length Configuration Feature for Various Band Sizes
- ✓ Adjustable Alignment Feature for Various Band Sizes
- ✓ Automatic Fabric Roll Pulling and Tension Control
- ✓ Manufacturing Execution System (MES) Data Transportation Feature Available

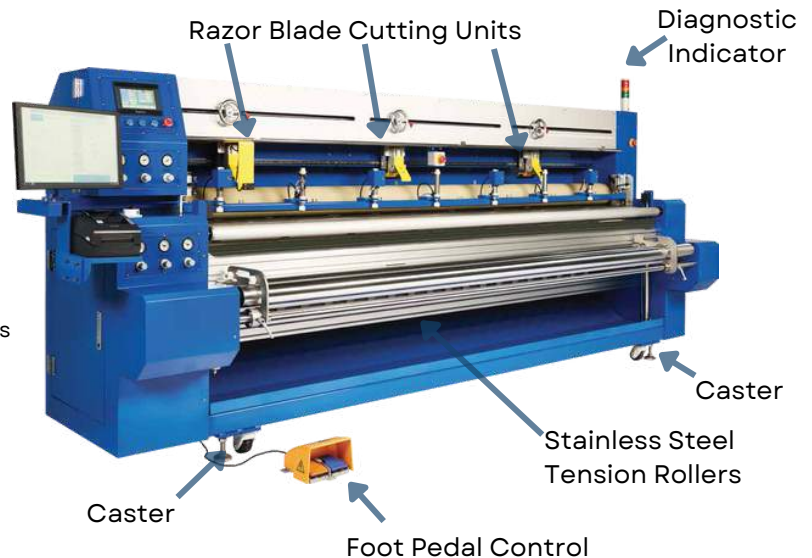

ULTRA XTC 2.0



The **ULTRA XTC 2.0 Saw Cutting Machine** can be used to cut **aluminum tubing, fascias, cassettes, thin-wall conduit, head rails, bottom rails, and light metals**. The cutting machine features a pneumatic clamp system, and length stopper with measuring tape. An adjustable cutting edge can also be an added option.

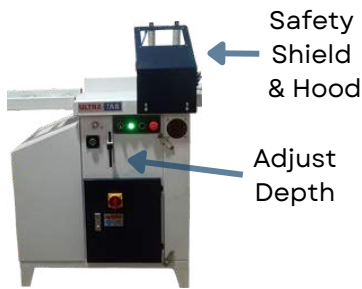

Safety Shield & Hood

Adjust Depth

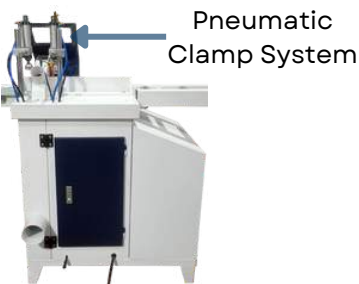

Pneumatic Clamp System



TECHNICAL SPECIFICATIONS:

Maximum Cutting Capacity: Up to 5" (130mm)

Wrench Size: 36

Voltage: 220V, 3 Phase

Air Requirements: 6-8 bar (kg/cm²) or 90-110 psi



EQUIPMENT DIMENSIONS (WxLxH):

Machine Dimensions: 28" x 26" x 53"

Roller Tray Dimensions: 78" x 12" x 37"

Saw Blade Diameter: 455mm x 4mm x 170T

Saw Blade Inner Diameter: 25.4 mm



OPTIONAL UPGRADES:

Additional 78" Roller Tray

90° and 45° Angle Cut

Rubber Coated Roller Tray



[▶ Watch the Demo](#)

Features

- ✓ Metal Roller Tray: Allows the tubes to slide with ease
- ✓ 78" Tray on Both Sides of Cutter
- ✓ Length Stopper: Ensures that the cut is the correct length
- ✓ Pneumatic Clamp System
- ✓ Vacuum to Collect Metal Debris
- ✓ 90° Angle Cut
- ✓ Safety Shield and Hood

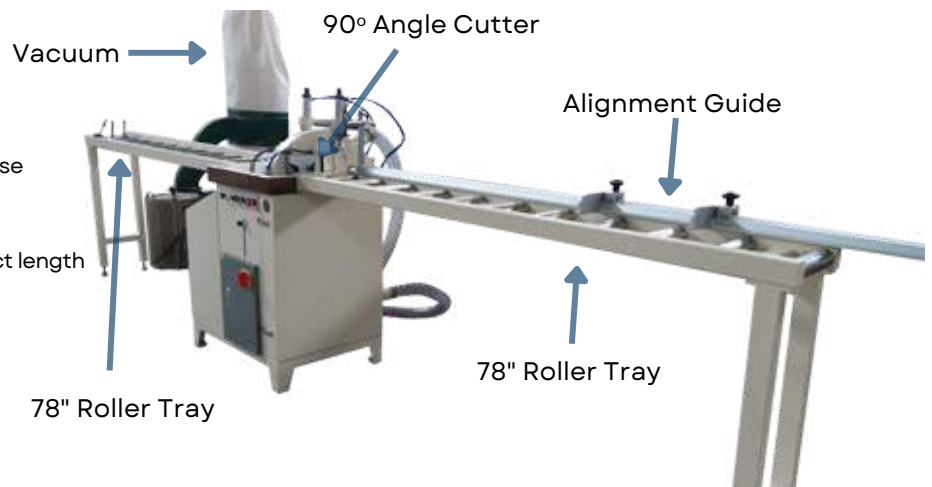



ULTRA RBS

The **ULTRA RBS Blade Sharpener** can sharpen a variety of round blades, in various metals and sizes. By re-sharpening dull blades users are able to maximize their investment and ensure their equipment provides a clean, sharp cut each and every cut. The grinding wheel runs in a water bath to prevent residue buildup on the grinding wheel and keep tools cool while sharpening.

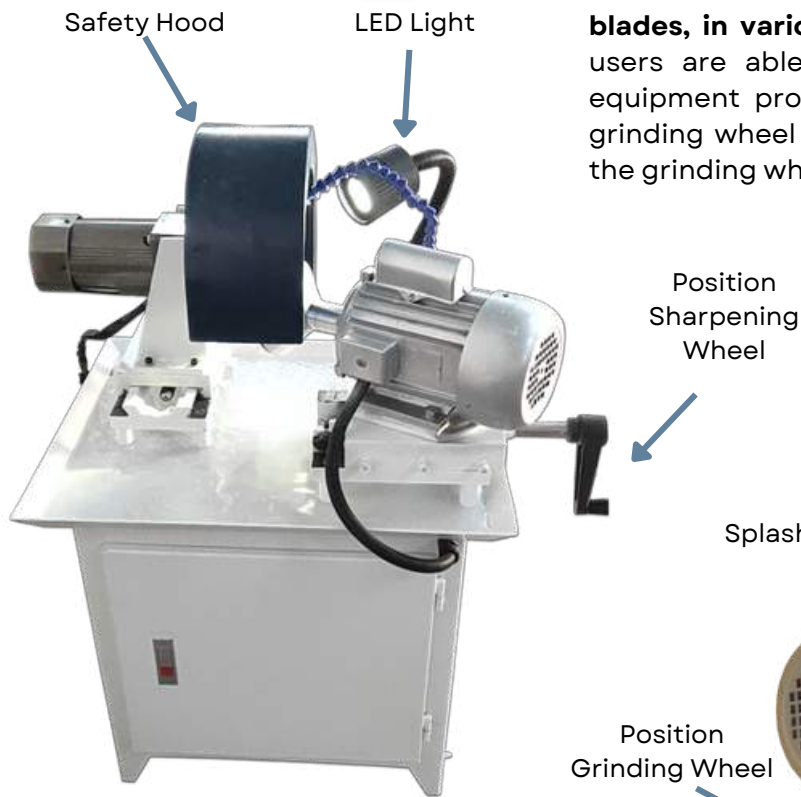

TECHNICAL SPECIFICATIONS:

- Round Blade Diameter:** 45mm to 100mm
- Grinding Angle:** 30° - 40°
- Wheel Speed:** ~1400 RPM
- Wattage:** 700 Watts
- Voltage:** 110V or 220V, Single Phase
- Machine Dimensions:** 32" x 24" x 36" (WxLxH)

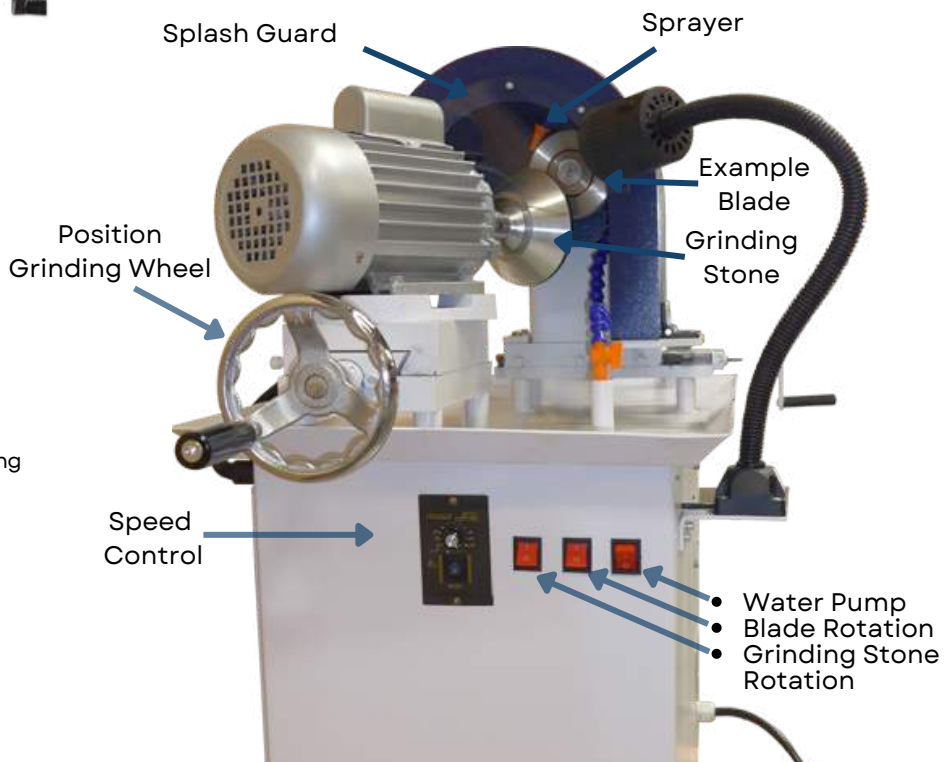

Features

- ✓ Improved Cut, Sharper Blade Minimizes Fraying
- ✓ Adjustable Grinding Angle
- ✓ Adjustable Rotation Speed
- ✓ Water Pump Cooling System
- ✓ Splash Guard
- ✓ Convenient Gooseneck Light Fixture



ULTRA WS

Using impulse sealing technology and precision controlled welding parameters the **ULTRA WS Automatic Impulse Welder** is able to automatically create shade pockets, and join large fabrics together for **over-sized windows**. It is designed with an open space at the ends of the machine for welding shades wider than the machine. Weights and joining tools are included to make this process even faster and easier. The welder is constructed for single user operation, which saves both money and production time.

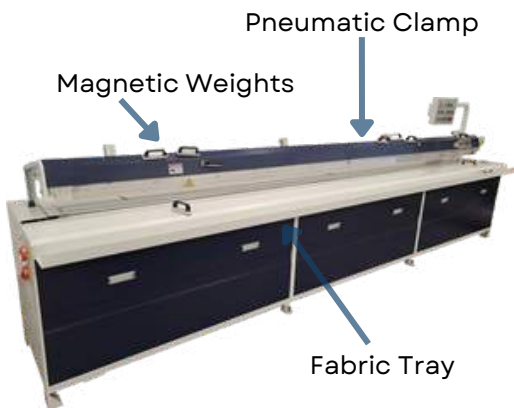

WELDING/FOLDING WIDTHS:

- 3.2M (10' 6")
- 4.0M (13' 1")
- 4.5M (14' 9")



TECHNICAL SPECIFICATIONS:

- Welding Seam:** 8mm
- Pocket Dimensions:** 0.6" - 2.4"
- Cycle Time:** 50-70 seconds
- Amperage:** 30 Amps
- Voltage:** 220V, Single Phase
- Wattage:** 15,000 or 18,000 Watts
- Air Requirements:** 6-8 bar (kg/cm²) or 90-110 psi

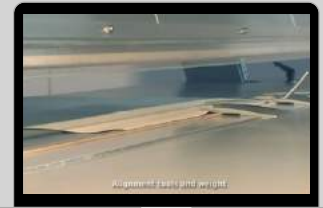

[Watch the Demo](#)



OPTIONAL UPGRADES:

- Spline/Zipper Plate
- 10mm Welding Seam
- LED Inspection Light Strip - **NEW**



Features

- ✓ Automatic Folding and Seaming
- ✓ Adjustable Pocket Depth
- ✓ Adjustable Heat Settings
- ✓ Weld-Cycle Counter - **NEW**
- ✓ Safety Features Located on the Front and Back of Unit
- ✓ Bonding Tape Dispenser
- ✓ Weights and Joining Jiggs Included
- ✓ Weld most roller shade materials with and without bonding tape

Adjust Pocket Margin

Emergency Stop Pull-Switch

Adjust Pocket Depth

Spline/Zipper Plate

On/Off Switches:
 • Top Weld
 • Bottom Weld



ULTRA WX

Using impulse sealing technology and precision controlled welding parameters the **ULTRA WX Digital Impulse Welder** is able to automatically create shade pockets, and join large fabrics together for over-sized windows. It even has the ability to weld shades wider than the machine. The digital design allows users to save up to 100 custom cooling and heating times. By programming your preferred heating/cooling times for your fabrics the ULTRA WX will truly minimize welding production time and maximizes productivity.



WELDING / FOLDING WIDTHS:

- 3.2M (10' 6")
- 4.0M (13' 1")
- 4.5M (14' 9")



TECHNICAL SPECIFICATIONS:

- Welding Seam:** 8mm
- Pocket Dimensions:** 0.6" - 2.4"
- Cycle Time:** 50-70 seconds
- Amperage:** 30 Amps
- Voltage:** 220V, Single Phase
- Wattage:** 15,000 or 18,000 Watts
- Air Requirements:** 6-8 bar (kg/cm²) or 90-110 psi



OPTIONAL UPGRADES:

- Spline/Zipper Plate
- 10mm Welding Seam
- LED Inspection Light Strip - **NEW**



[▶ Watch the Demo](#)

Features

- ✓ Automatic Folding and Seaming
- ✓ Adjustable Pocket Depth
- ✓ Adjustable Heat Settings
- ✓ PLC Control Panel - Program up to 100 Welding and Cooling Times
- ✓ Weld-Cycle Counter - **NEW**
- ✓ Safety Features Located on the Front and Back of Unit
- ✓ Bonding Tape Dispenser
- ✓ Weights and Joining Jiggs Included
- ✓ Weld most roller shade materials with and without bonding tape



Emergency Stop Pull-Switch

Spline/Zipper Plate

Touch Screen, PLC Control Panel

On/Off Switches:

- Top Weld
- Bottom Weld



ULTRA MG

Using impulse sealing technology and precision controlled welding parameters the **ULTRA MG Digital Impulse Welder** is able to automatically create shade pockets. The PLC Control Panel provides users with an easy to operate touch screen interface to adjust the pocket size, heating temperature/time and cooling time to ensure a strong, even weld, each and every time. Users are able to join large fabrics together effortlessly but using the automatic overlap mode, there is no need for alignment jigs or tools.



WELDING / FOLDING WIDTHS:

5M (16' 5")
6M (19' 8")
7M (23')



OPTIONAL UPGRADES:

Zipper or Keder Insert
10mm Welding Seam (5M/6M units)
12mm Welding Seam (7M unit only)
LED Inspection Light Strip - **NEW**



TECHNICAL SPECIFICATIONS:

Welding Seam: 6mm (5M/6M units), or 10mm (7M unit)
Pocket Dimensions without Zipper Insert: 0.7" - 2.75"
Pocket Dimensions with Zipper Insert: 1.38" - 2.75"
Cycle Time: 50-70 seconds
Amperage: 30 Amps
Voltage: 220V, Single Phase
Air Requirements: 6-8 bar (kg/cm²) or 90-110 psi
Control: Programmable Logic Controller



[▶ Watch the Demo](#)

Features

- ✓ Automatic Pocket Welding
- ✓ Heating and Cooling Timer
- ✓ Automatic Overlap Mode to Join Fabric Panels
- ✓ Easy ZIGs and Magnets for Joining Fabric Panels Included
- ✓ Safety Features Located on the Front and Back of Unit
- ✓ Welds most roller shade materials with/without bonding tape

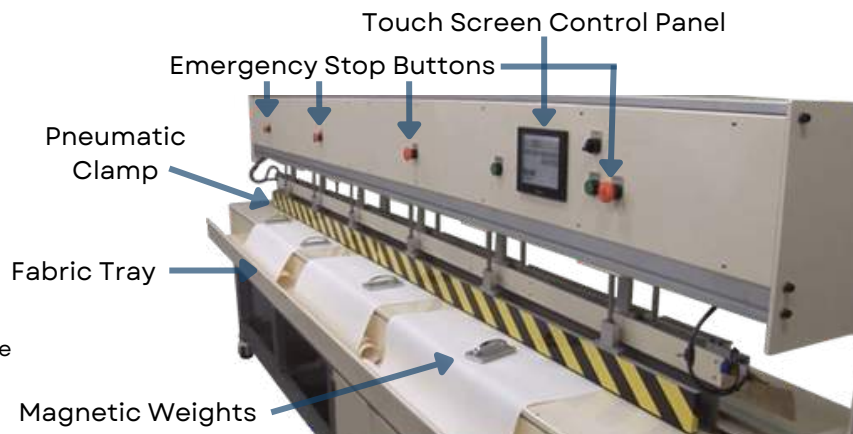

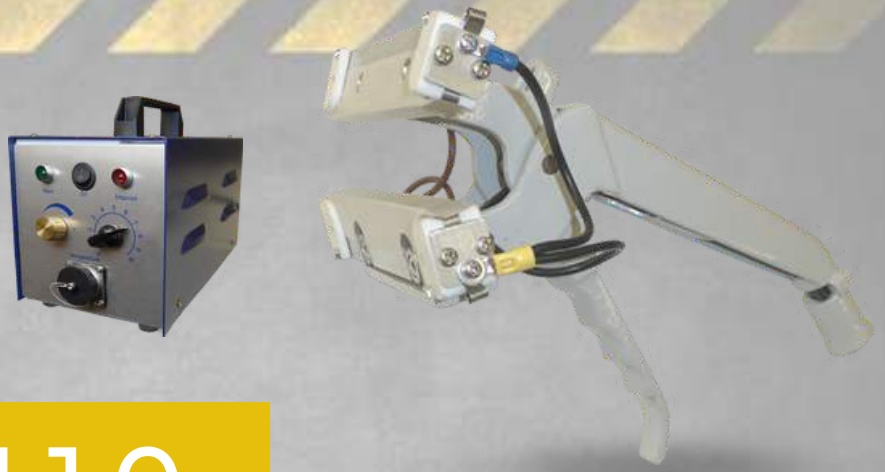

ULTRA WH 1.0

The **ULTRA WH 1.0 Handheld Impulse Welder** is designed to seal the end of a roller shade pockets. The compact size allows manufacturers to transport small, portable welder to different job sites or carry it from one side of the workroom to the other.

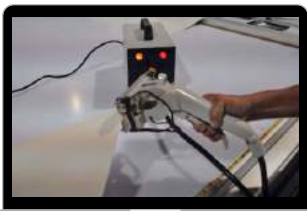

▶ Watch the Demo

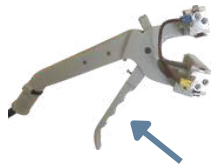

Hand Clamp



TECHNICAL SPECIFICATIONS:

Handheld Dimensions: 6.7"x12.2"x7.5"

Main Set Dimensions: 14"x9"x12"

Welding Width: 5"

Voltage: 110V or 220V, Single Phase

Wattage: 300 Watts



OPTIONAL UPGRADES:

Cable Extension



MANUFACTURER WARRANTY

Within the first 12 months you receive the machine, we will repair/replace any manufacturing defect without charge for parts or labor.



FAST SHIP in 1-2 days:

FOB Monrovia, CA

Main Set Power Supply

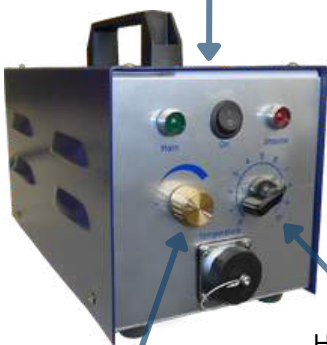

Heat Temperature Control

Heat Setting Intensity Control

Heating Element

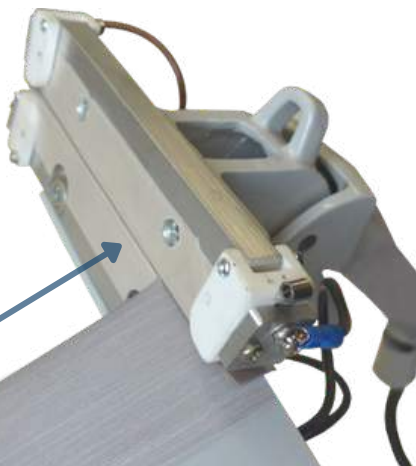

Features

- ✔ Portable, Compact Size
- ✔ Strong, Even Weld
- ✔ Quickly Seal End of Roller Shade Pockets
- ✔ Ideal for last minute touch-ups

ULTRA WH 2.0



The **ULTRA WH 2.0 Impulse Pocket-End Sealer** is designed to seal the ends of shade pockets. Adjustable guides, measuring tape and a positioning magnet are included to securely hold the material in place. Most users mount one on each end of their full-sized welder, to quickly slide and seal both ends of the shade without having to reposition the fabric and maintaining 100% accuracy.



▶ Watch the Demo



Main Set Power Supply

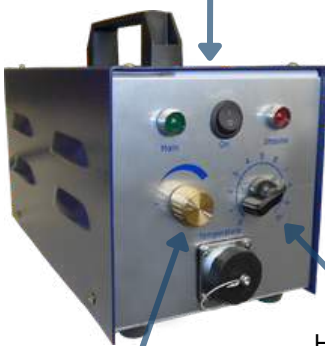

Heat Temperature Control

Heat Setting Intensity Control

Adjustable Guides with Measuring Tape

Positioning Magnet

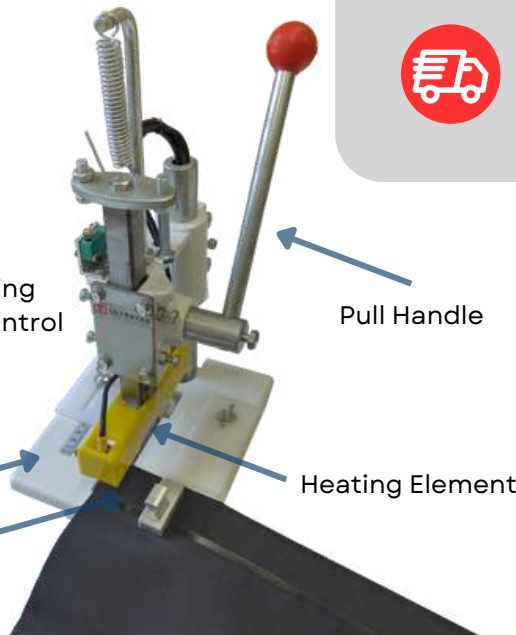

Pull Handle

Heating Element

TECHNICAL SPECIFICATIONS:

End Sealer Dimensions: 9"x8"x19"

Main Set Dimensions: 14"x9"x12"

Welding Width: 3.5"

Voltage: 110V or 220V, Single Phase



OPTIONAL UPGRADES:

Cable Extension



MANUFACTURER WARRANTY

Within the first 12 months you receive the machine, we will repair/replace any manufacturing defect without charge for parts or labor.



FAST SHIP in 1-2 days

FOB Monrovia, CA

Features

- ✔ Quickly seal end of roller shade pockets
- ✔ Compact Size
- ✔ Strong, Even Weld
- ✔ Adjustable Guides with Measuring Tape
- ✔ Positioning Magnet

ULTRA PT

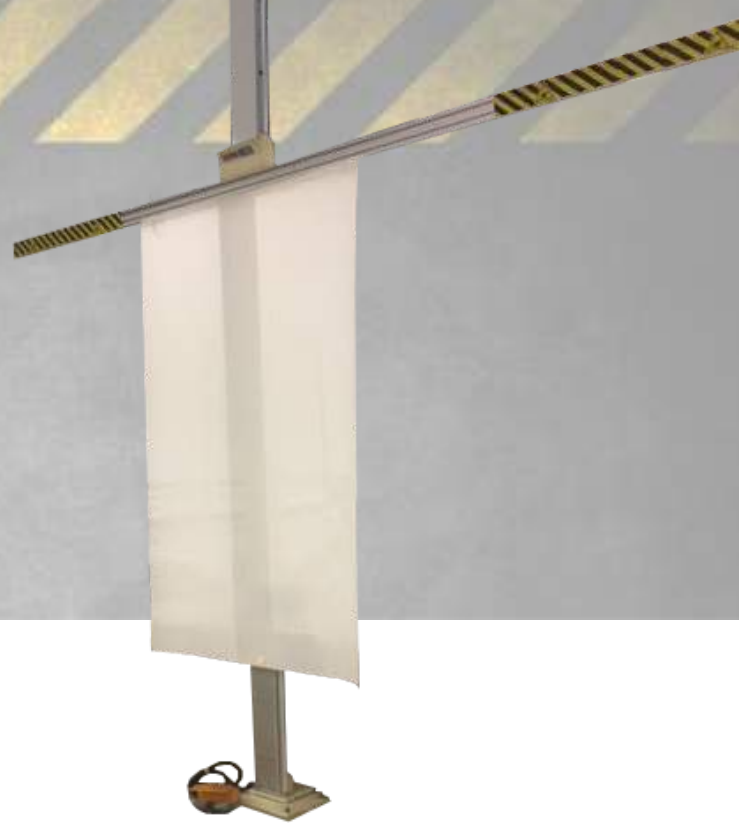

▶ Watch the Demo

The **ULTRA PT Inspection Hoist** is used to effectively demonstrate and test the shade in the convenience of your workshop, prior to the installation. It is important to make sure the shade was assembled correctly and runs smoothly before installation. The motorized lift bar is controlled by an electric foot switch and can lift up shades up to 135 lbs. Safety is always a top concern, we have implemented emergency stops so that in the event of a power outage the lift bar will not dead fall.



LIFTING CAPABILITIES:

Max. Lifting Weight: 135 lbs
Max. Lifting Height: 4.0M (13' 1")
Max. Lifting Width: 4.0M (13' 1")



TECHNICAL SPECS:

Height of Hoist: 4.5M (14' 9")
Width of Lift Bar: 4.0M (13' 1")
Voltage: 110V or 220V ,
Single Phase
Wattage: 370 Watts



OPTIONAL UPGRADES:

Custom Sizes Available

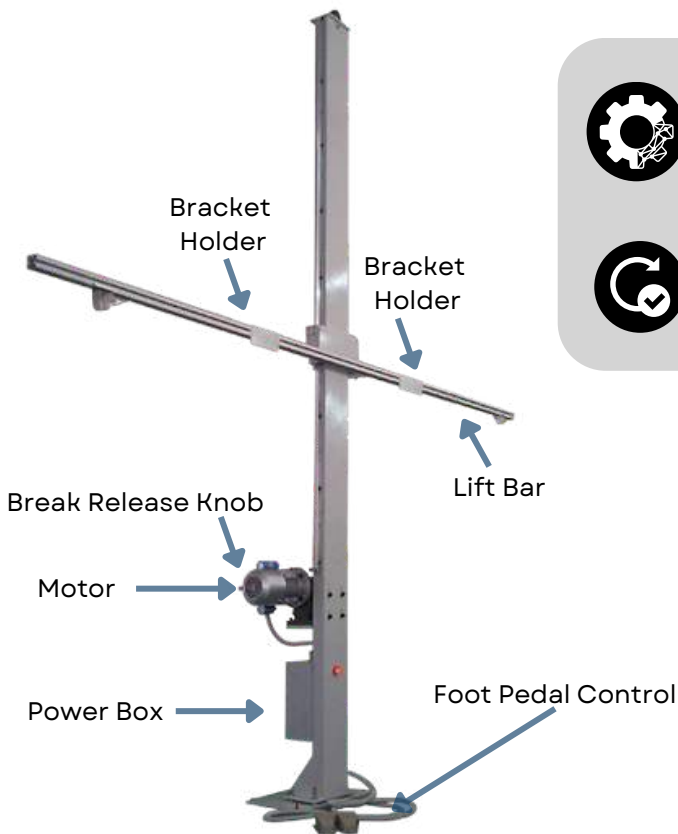

Features

- ✓ Wide Lift Bar
- ✓ Lift Shades up to 135 lbs
- ✓ Lift Shades up to 13ft long
- ✓ Electric Foot Switch
- ✓ Emergency Stop Bar



ULTRA PTX



The **ULTRA PTX Inspection Hoist** provides a steady, secure platform in your workshop to test the functionality and operation of the shades. By simply mounting the shade brackets to the lift bar, controlled by an electric foot switch users can raise and lower the shades to ensure the shade hardware is working properly, as well as evaluate the color, texture, and measurements are accurate. The ULTRA PTX can lift shades up to 180 lbs and features emergency stops so that in the event of a power outage the lift bar will not deadfall.

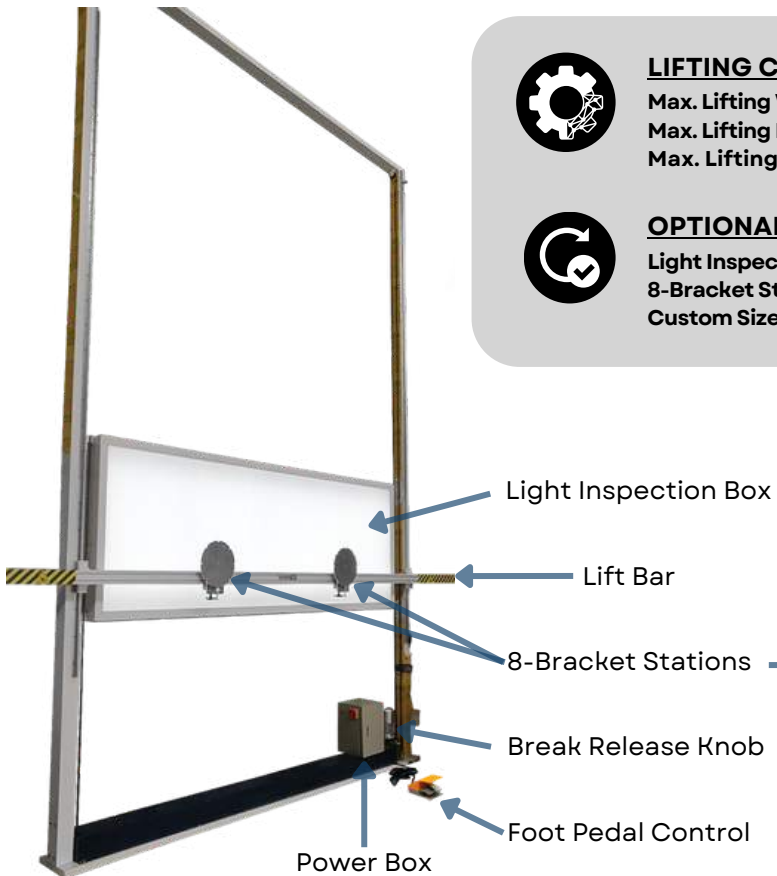

LIFTING CAPABILITIES:

Max. Lifting Weight: 180 lbs
Max. Lifting Height: 4.0M (13' 1")
Max. Lifting Width: 4.0M (13' 1")



OPTIONAL UPGRADES:

Light Inspection Box
8-Bracket Station
Custom Sizes Available



TECHNICAL SPECIFICATIONS:

Height of Hoist: 4.5M (14' 9")
Width of Lift Bar: 4.0M (13' 1")
Voltage: 110V or 220V, Single Phase
Wattage: 370 Watts

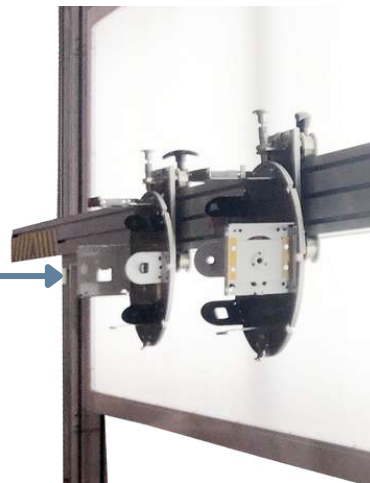

Features

- ✓ Wide Lift Bar
- ✓ Lift Shades up to 180 lbs
- ✓ Lift Shades up to 13ft long
- ✓ Electric Foot Switch
- ✓ Emergency Stop Bar



ULTRA TM2

The **ULTRA TM2 Tube Taping Machine** applies double-sided tape on tubes for roller blinds. It quickly creates perfectly straight, uniform tape placement on each and every tube. 18-55mm diameter rolls and 8-30mm tape widths can be used.

Features

- ✓ Fully Automated
- ✓ Motorized Roller System
- ✓ Touch Screen Display
- ✓ Tape is Cut by Razor
- ✓ Adjustable Speed Control



 Watch the Demo

TECHNICAL SPECIFICATIONS:

Working Tube Diameter: 18mm - 50mm
Working Tape Widths: 8mm - 30mm
Tray Lengths: 2M (6' 7")
Voltage: 110V or 220V, Single Phase
Control Panel: HMI Operation



EQUIPMENT DIMENSIONS:

Machine: 24" x 32" x 59" (WxLxH)
Material Feeding Table: 20" x 79" x 30" (WxLxH)



OPTIONAL UPGRADES:

Additional Trays



2M (6' 7") Tray

2M (6' 7") Tray

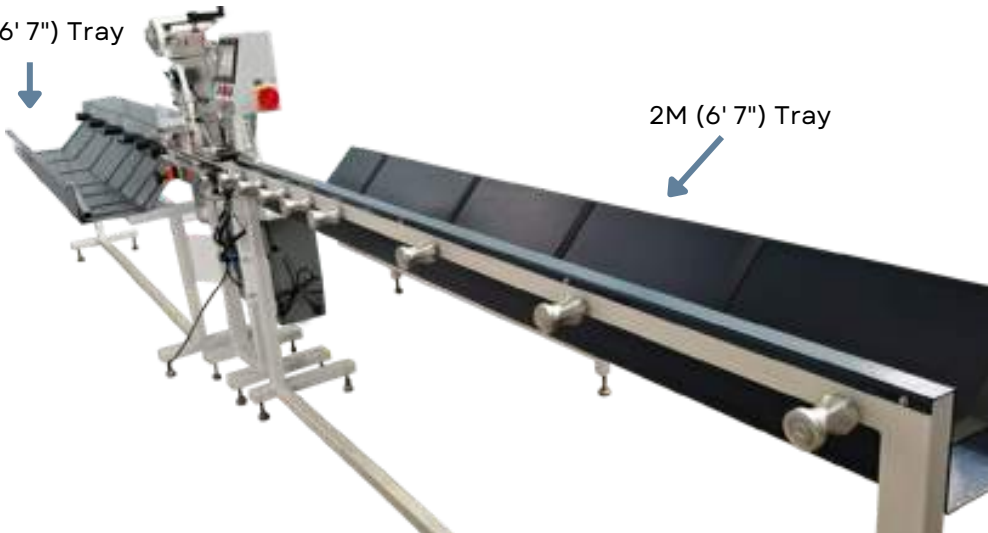



ULTRA RG

The **ULTRA RG Winding Device** is used to quickly roll and unroll shades. Powered by a simple electric foot switch, this machine provides manufacturers with easy, efficient shade-assembly.



WORKING WIDTHS:

- 3.2M (10' 6")
- 4.0M (13' 1")
- 4.5M (14' 9")



TECHNICAL SPECIFICATIONS:

- Air Requirements:** 6 kg/cm²
- Voltage:** 110V or 220V, Single Phase



OPTIONAL UPGRADES:

- Adapters for Various Size Tubes

[▶ Watch the Demo](#)

Features

- ✓ Motorized Roller System
- ✓ Control Speed
- ✓ Control Direction
- ✓ Pneumatic Clamp
- ✓ Electric Foot Switch
- ✓ 1Tube Adapter

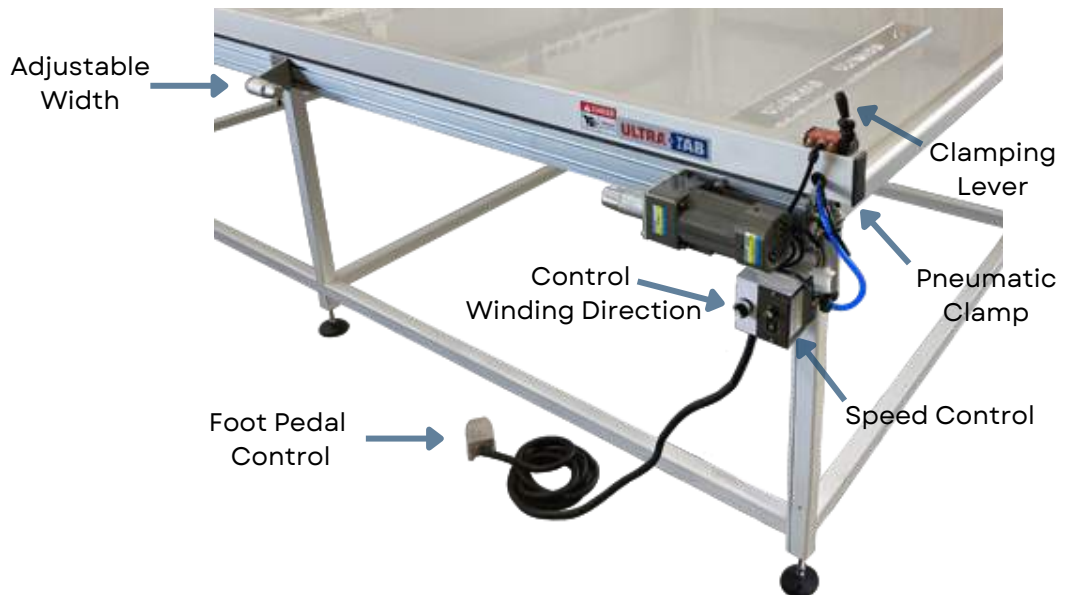



ULTRA FRC

Using six steel rollers, the **ULTRA FRC Fabric Roller Cradle** makes unrolling material a breeze. It comes equipped with castors that can lock the cradle in place or unlocked to move to another area of the workroom to position alongside cutting tables, welding equipment, or even transport a heavy roll across the room with ease. By using the ULTRA FRC, the manual labor of handling the fabric rolls is reduced and worker productivity will increase.



Features

- ✓ Able to Cradle Rolls up to 8-12" Diameter
- ✓ 6 Steel Rollers
- ✓ Wheels for Easy Positioning
- ✓ Added support helps reduce injury
- ✓ Improve efficiency by quickly maneuvering material from one work station to the next



WORKING WIDTHS:

2.0M (6' 7")



DIMENSIONS:

Width: 78"
Length: 25"
Height: 37"



SERVICE & SUPPORT

At Ultratab, we offer customized maintenance programs to prevent equipment down-time when you need it most. To accomplish this goal, our trained technician will perform routine inspections, maintenance and repairs on your Ultratab machines as the manufacturer intended.

Our Planned Maintenance Programs will maximize your equipment's reliability, performance, and overall quality by ensuring professional routine maintenance and inspections are completed by our trained technicians. When equipment is exposed to regular workloads and usage, they are bound to have a decrease in effectiveness without proper care. If neglected, worn parts can lead to the failure of other critical components.

We have learned that preventive maintenance reduces and eliminates unexpected issues by promoting optimal equipment performance. Getting your PM Program in place is a sure way to protect your investment. Keep your machine's up-time at its maximum, and efficiency at its peak with regular servicing and multi-point checks. Having the peace of mind knowing your equipment will always be in great working order is invaluable; leaving you with the ability to focus on running your business without any unexpected costs machine breakdown.

Contact your sale and service representative for your customized plan.

USA, Canada, and Latin America:



SENBESTA

PHONE: +1 (626) 256-4800
EMAIL: sales@senbesta.com
ADDRESS: 1901 S Mountain Ave
Monrovia, CA 91016 USA
WEBSITE: www.senbesta.com
DEMO VIDEOS: www.youtube.com/ultratab

Asia, Europe, Africa, and Australia:



PHONE: +852 2331 2121
EMAIL: pacino@ultratab-asia.com
ADDRESS: Flat D, 5/F, Yeung Yiu Chung,
(No.8) Ind. Bldg, No. 20 Wang Hoi Road
Kowloon Bay, Hong Kong, China